

FRONT VIEW

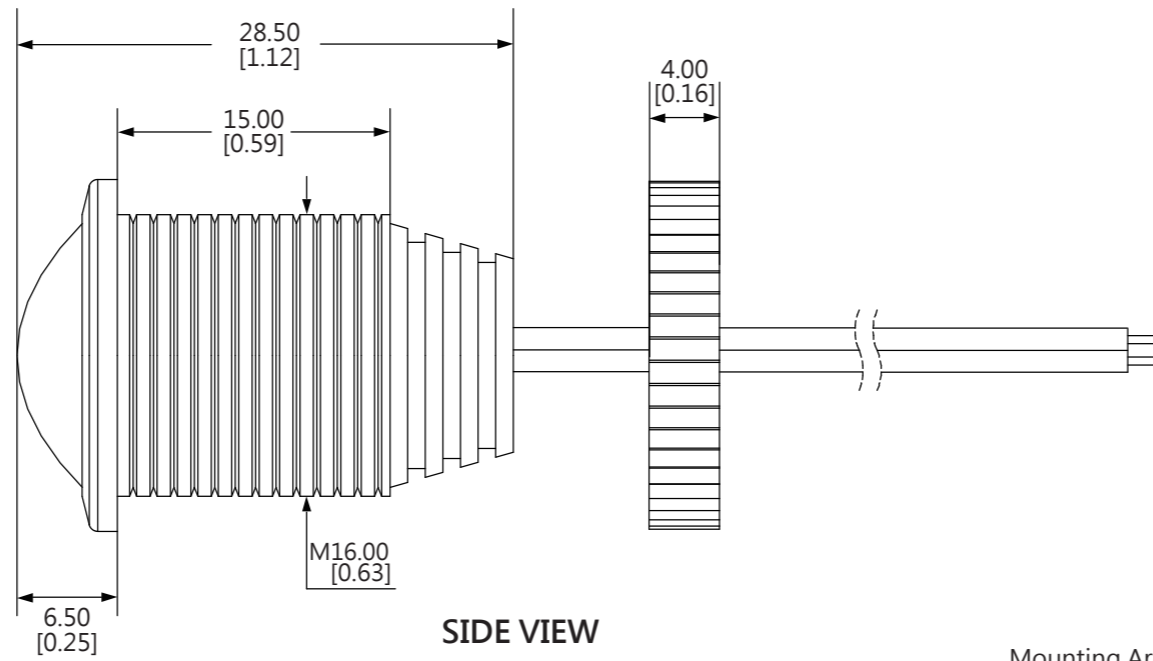

SIDE VIEW

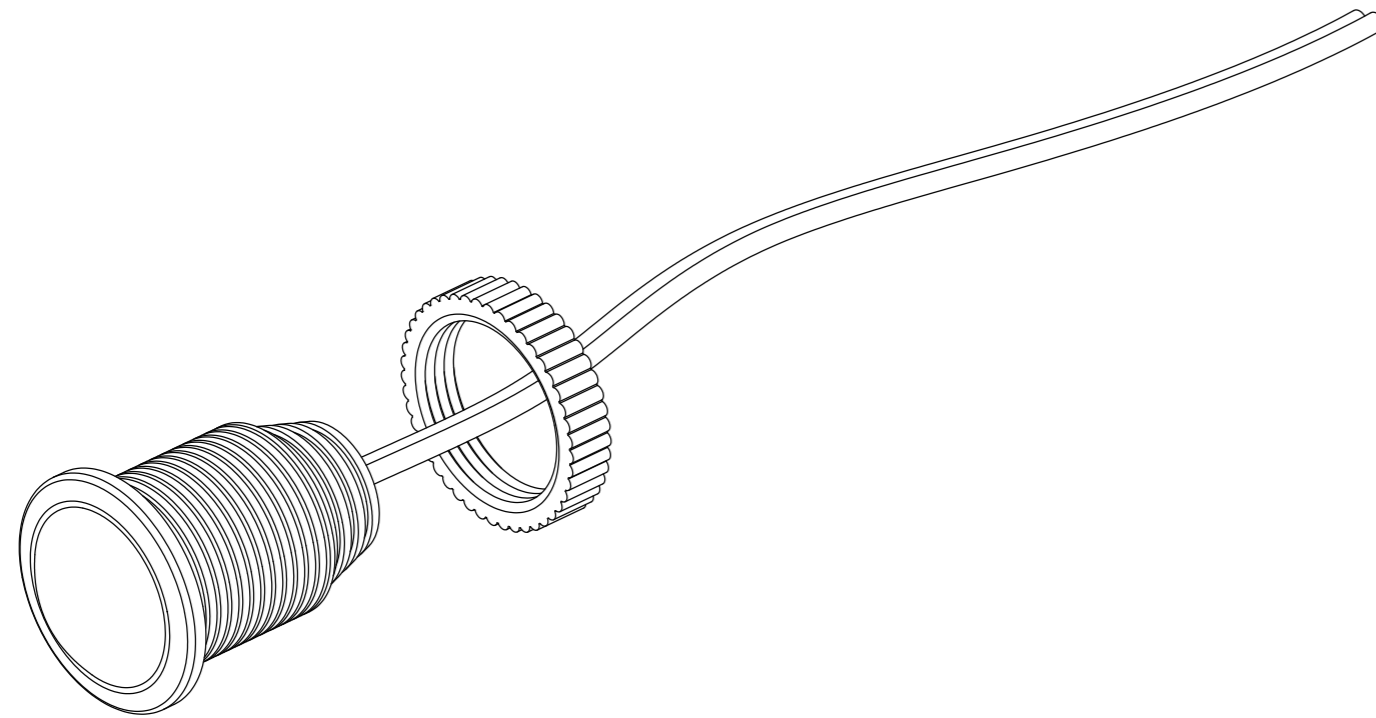

ISOMETRIC VIEW

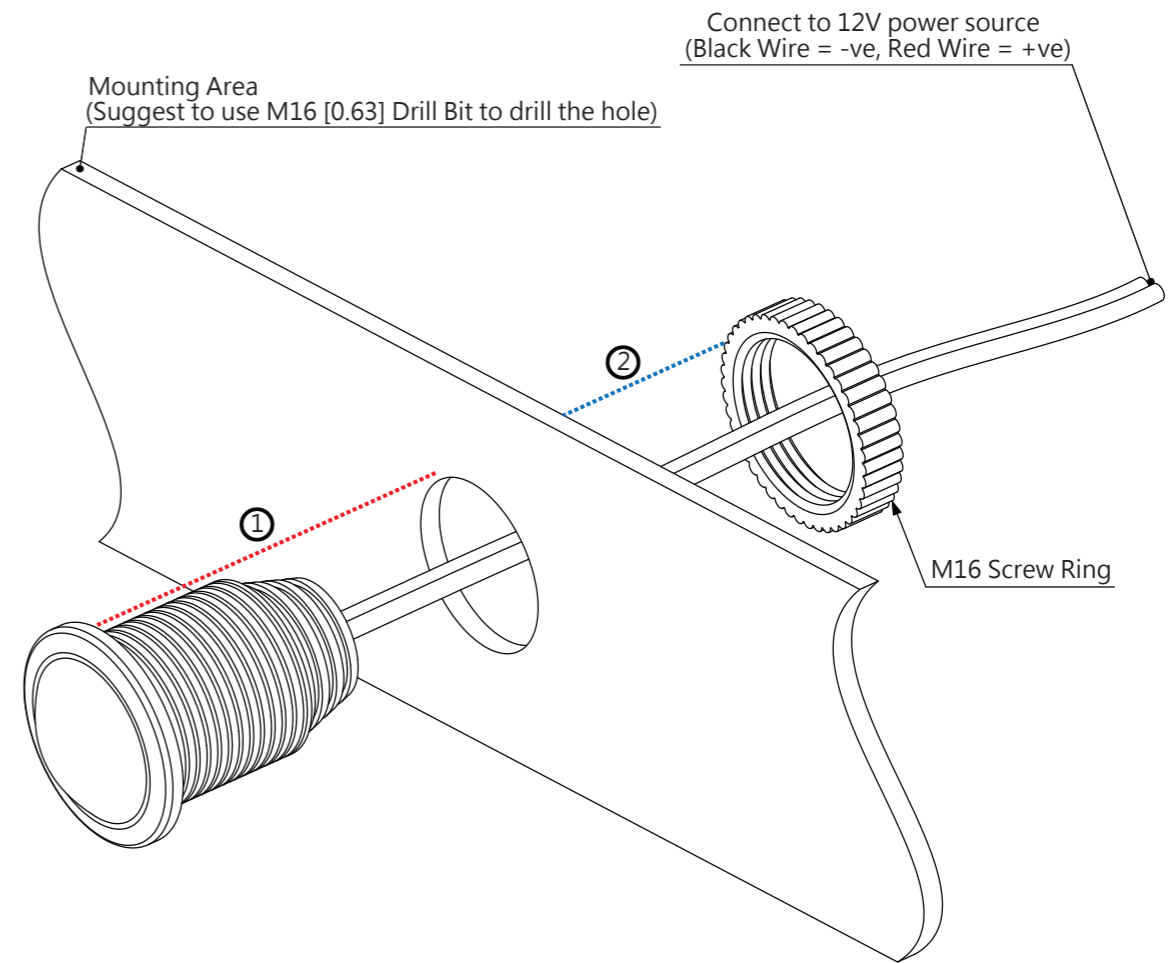

INSTALLATION DIAGRAM

All dimensions in millimeters [Inches]

Technical Information (Per module):			
Operating Voltage: DC 12V			
Number of LEDs: 1 LED		16mm High Intensity Flush Mount LED Bolt(With LEN)	
Maximum Power Consumption: 38 mA (0.46W)		DRAWING NUMBER:	VERSION:
Heat Dissipation: Below 45 C / 113 F		OZ100-02	A
Net Weight: 20g		PAGE:	1 of 1